















Vehicle Model	Cadenza	Accessory	Bumper Applique
Model Year	2014~	Difficulty	(B)
Part No.	3R027 ADU00 (FOR DIO) 3R027 ADUP0 (FOR PIO)		

• Accessory Installation

 Denotes warnings that may lead to serious physical injury or vehicle damage.	 Denotes quality processes to be checked prior to moving to the next step.	Denotes safety equipment required to be used such as a mask, goggles, rubber gloves, and hearing protection.	
 Denotes cautions to be taken to avoid physical injury or electronic component damage.	 Denotes specific tools that are necessary to complete the step.	 Mask	 Goggles
 Denotes cautions to be taken to avoid vehicle and component damage.	 Denotes instructional steps necessary to complete the process.	 Rubber Gloves	 Hearing Protection

Note: Difficulty stated above reflects the minimum level of expertise required to install the accessory
(A) Customer (B) Dealer Technician (C) Master Technician

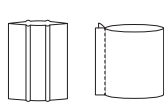
Basic Required Hand Tools

 Alcohol & Water	 Slip		
50/50 Isopropyl Alcohol (70%) & Water	Alcohol, Soap & Water	Squeegee with Sleeve	Microfiber Cloth

Preparation - Before Installation :

- Alcohol, Water & Shampoo:** Mix 8oz Alcohol (70% isopropyl), 8oz of water, and 1ml of baby shampoo in a trigger type spray bottle marked "Slip". **Note:** The above listed solution has been formulated for use where ambient + vehicle surface temperature are within a range of 65°F to 90°F. If temperatures exceed this range, add additional shampoo in increments of 1ml.
- This product should be installed with proper installation tools.
- Install this product while observing all warnings and precautions stated in this instruction booklet.
- VERY IMPORTANT:** Thoroughly wash rear bumper area with soap and water. If contaminants are found, clean with an automotive grade clay bar.
- VERY IMPORTANT: Sleeve must be installed on Squeegee** throughout entire installation process.
- VERY IMPORTANT:** Ambient temperature of the Bumper Applique and vehicle must be 65°F to 90°F at the time of installation and for two hours after.
- Parts storage should be flat at room temperature and in a clean dry place. **Care should be taken to avoid a dusty environment.**
- Place a large towel or pad on the ground to catch wetting mixture.

Notes to the Installer :

- Read the entire installation pamphlet prior to beginning the installation of the accessory.
- Ensure that the vehicle is properly protected in the area that the accessory is to be installed.
- To prevent vehicle damage, never place tools on top of painted surfaces, seats, dash pad, console or floor carpet / mat.
- Always wear appropriate safety gear to include gloves and eye protection when required.
- After washing bumper area with soap and water and prior to installing the Bumper Applique, completely clean the installation area with isopropyl alcohol (70%) and water mixture. If contaminants are present after cleaning, remove the contaminants using an automotive grade clay bar.
- Inspect part for any dirt or debris on adhesive.

VERY IMPORTANT: Installers hands must be completely clean from dirt and or grease.

KIA Genuine Accessories

Kit Overview

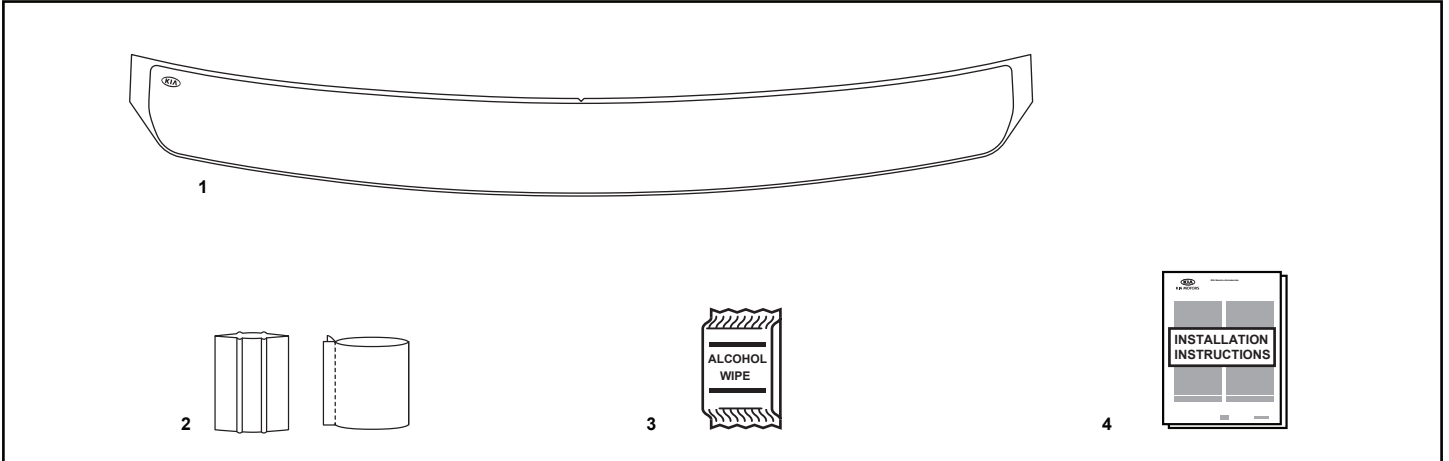

No.	Qty.	
1	1	Bumper Applique
2	1	Squeegee with Sleeve
3	4	Alcohol Pad
4	1	Instructions

Note: Items 2 and 3 are not included in PIO kit.

KIA Genuine Accessories

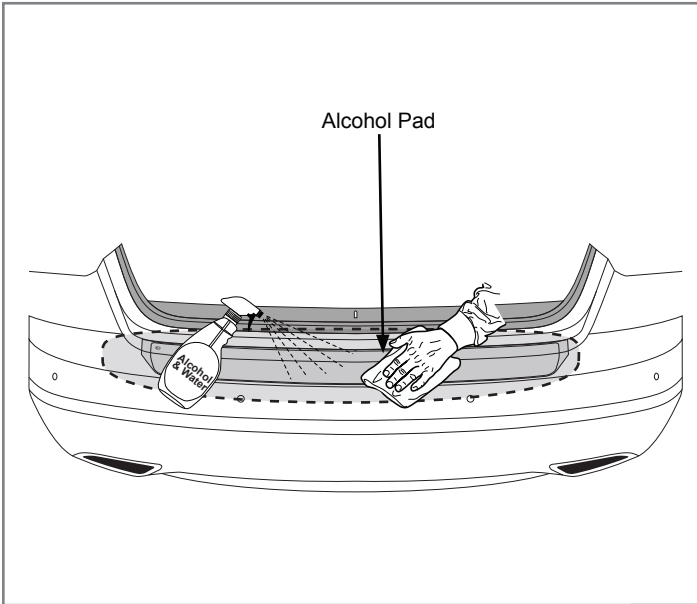

	Alcohol Prep Pad or Isopropyl Alcohol (70%) & Water Mixture in a Spray Bottle and a Microfiber Cloth.	1
N O T E	Thoroughly clean the bumper area using the alcohol prep pad or isopropyl alcohol and water mixture and a microfiber cloth.	
	Make sure bumper is completely clean and dried. Inspect bumper surface for contaminants. Clean surface with an automotive quality clar bar if required.	

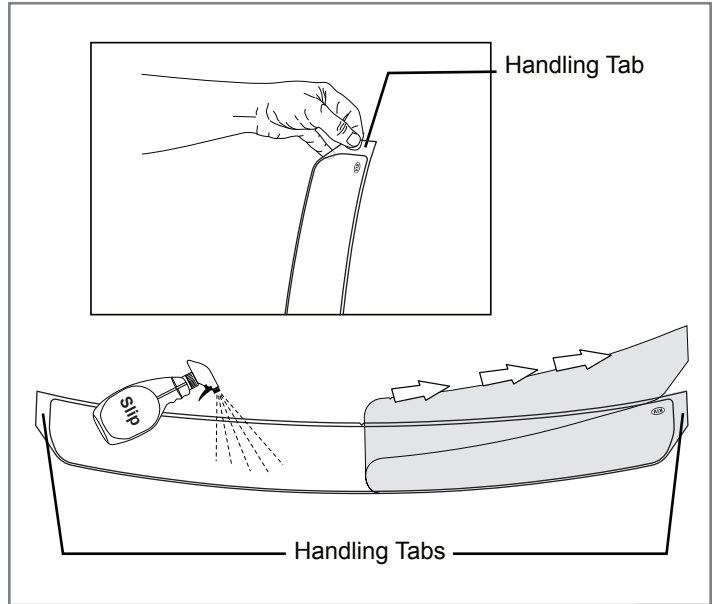

	Alcohol, Soap & Water Mixture (SLIP Mixture)	2
N O T E	Grasp only the Handling Tabs and remove the liner from the back of the Bumper Applique. Spray both the Bumper Applique and area of installation on the bumper with the SLIP mixture.	
	Pay special attention to not get any finger prints or dirt on the Bumper Applique.	

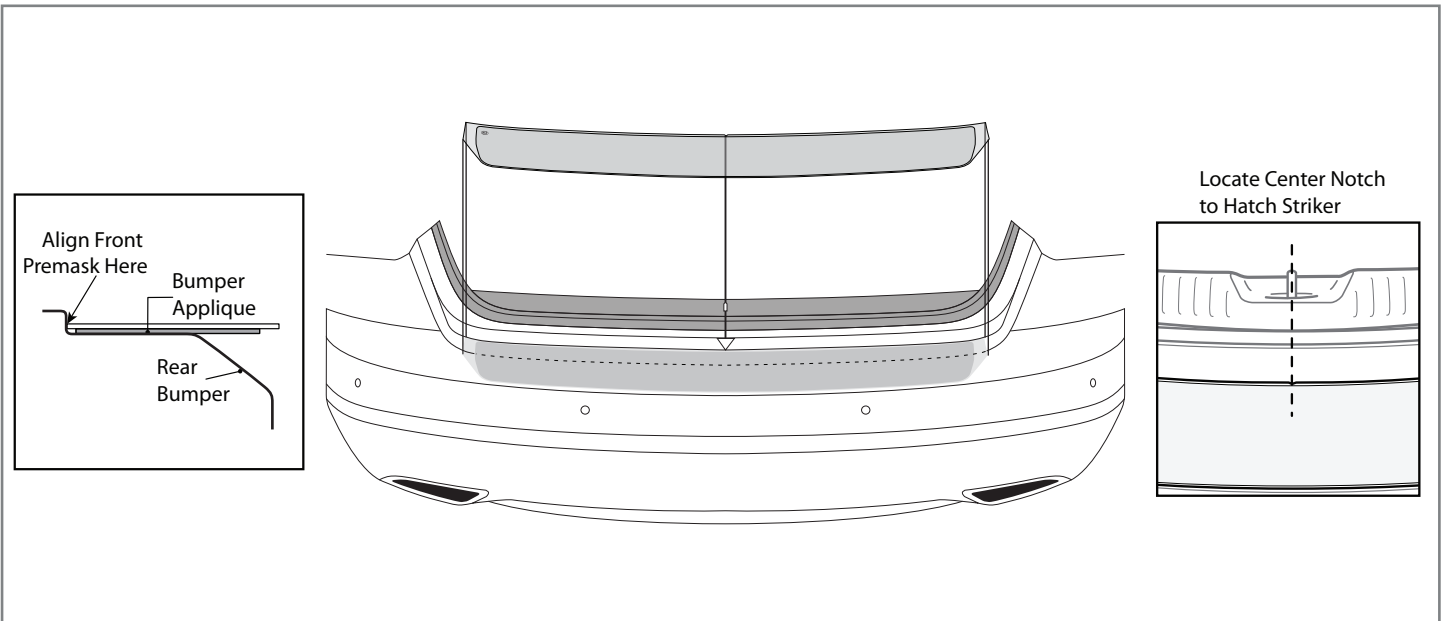

	Alcohol, Soap & Water Mixture (SLIP Mixture)	3
N O T E	With the vehicle still wet with the "SLIP" mixture, position the Bumper Applique onto the bumper by visually aligning the center notch in the premask to the hatch striker. If necessary, spray additional "SLIP" mixture to aid in the alignment.	
	Do not wrap the edge at this time. Bumper must be wet with SLIP mixture to aid in installation.	

KIA Genuine Accessories

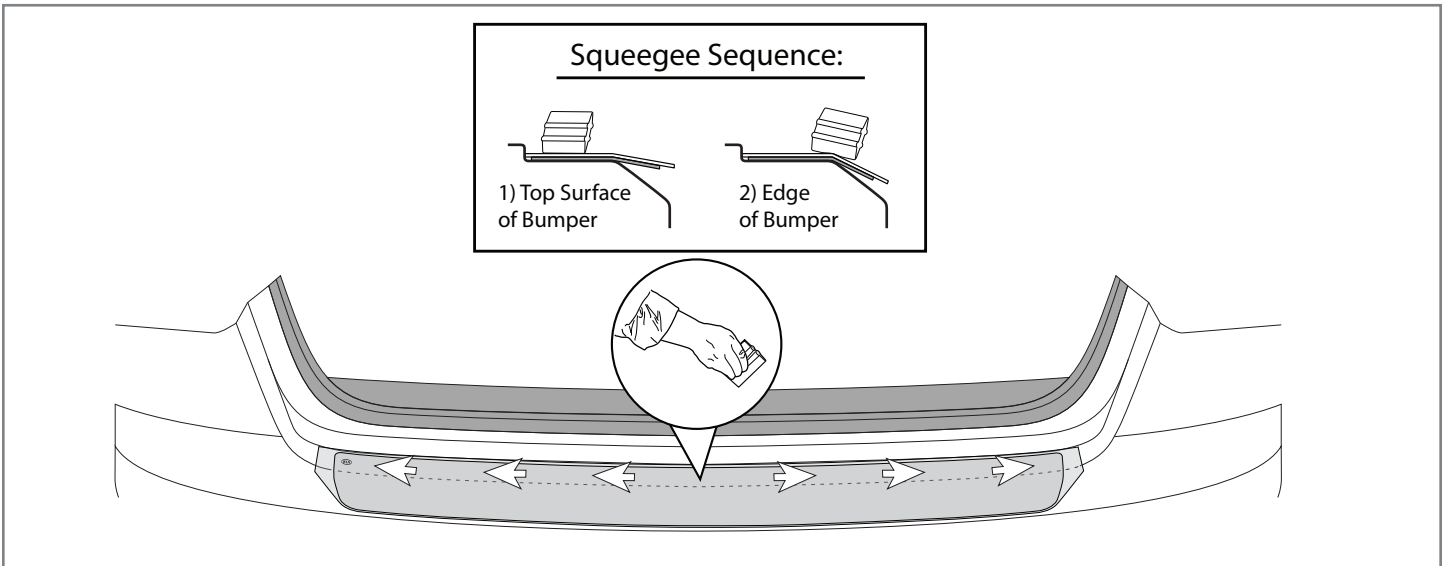



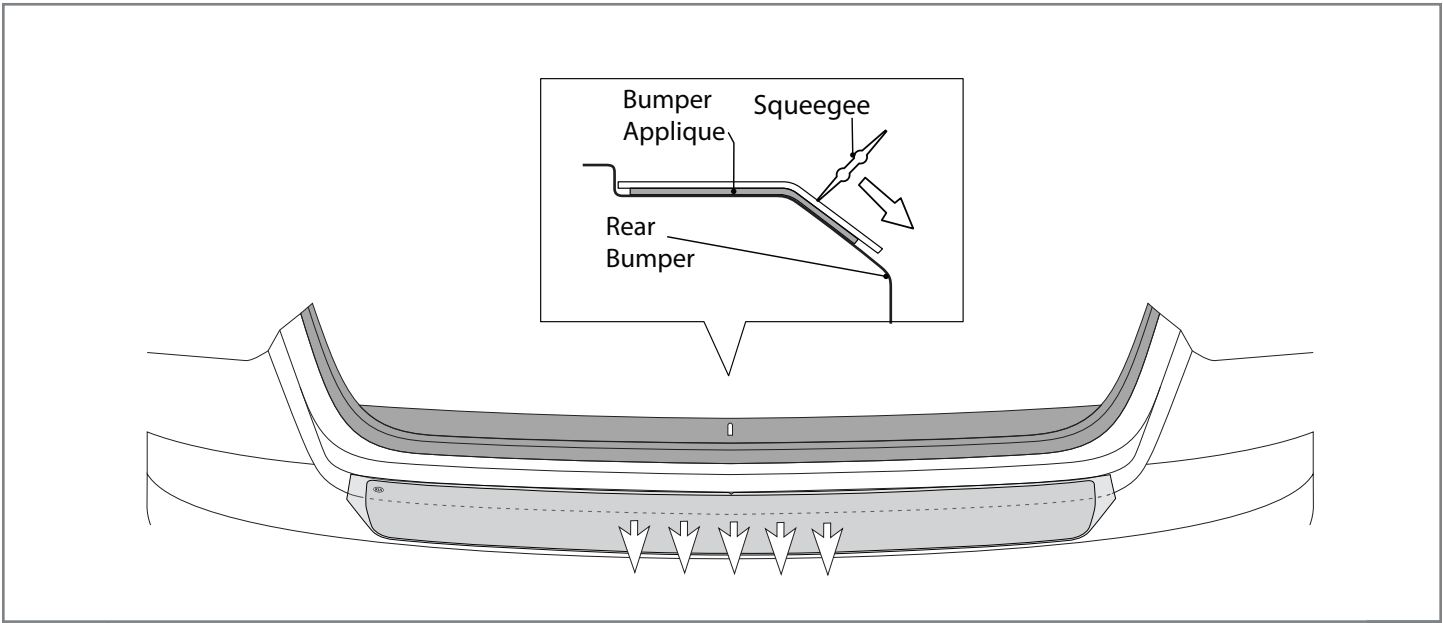

	Alcohol, Soap & Water Mixture (SLIP Mixture) and Squeegee with Sleeve	4
N O T E	Starting in the center, wet premask with slip mixture and squeegee the Bumper Applique firmly onto the top surface of the bumper using overlapping squeegee strokes. Continue to squeegee the edge of the bumper as shown above.	
	Inspect for bubbles. If bubbles are found, follow procedure in Visual Check to remove bubbles.	
	Do not squeegee the vertical surface at this time. Make sure sleeve is installed on squeegee.	



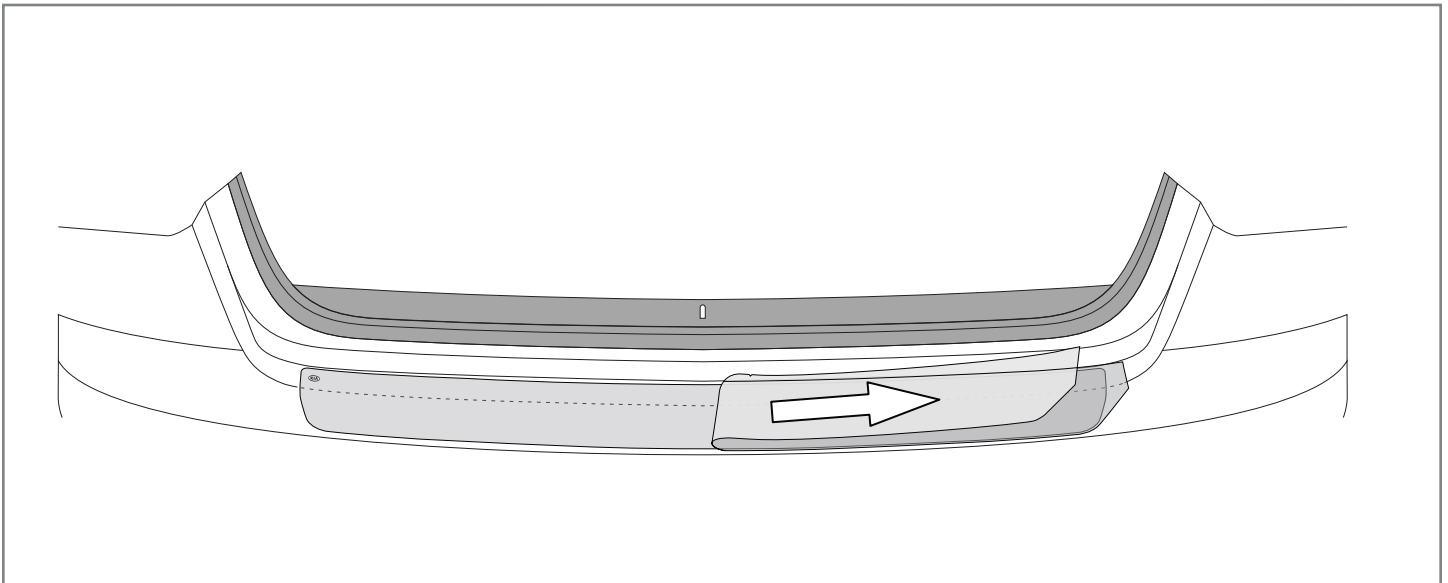



	Alcohol, Soap & Water Mixture (SLIP Mixture) and Squeegee with Sleeve	5
N O T E	Spray the partially applied Bumper Applique with the SLIP mixture and squeegee the remaining portion of the Bumper Applique to the bumper. It is very important to use a vertical squeegee stroke straight down. Continue this squeegee stroke pattern from the center, working outwards to complete the installation. Re-squeegee the entire part including any edges that may have lifted due to insufficient pressure.	
	Inspect for bubbles or lifting. Make sure sleeve is installed on squeegee.	

KIA Genuine Accessories



		6
N O T E	Carefully remove the premask at 180° from the Bumper Applique as shown above.	
	Do not pull premask straight up, this could lift Bumper Applique.	
	Inspect for bubbles or lifting.	

**KIA Genuine Accessories
Visual Check**

Items To Be Checked		Results Of The Check
	Use only the handling tabs when handling the Bumper Applique. Pay special attention to not get any finger prints or dirt on the Bumper Applique.	No dirt or finger prints on Bumper Applique.
	Check for bubbles. If bubbles are found, re-wet Bumper Applique with soap and water mixture and using a squeegee with sleeve, push/pull/remove bubbles to the closest edge of the Bumper Applique.	No bubbles present.
	Make sure Bumper Applique is fully adhered.	Bumper Applique is not lifting and is fully adhered. Take special care to make sure all edges are fully adhered.
	Make sure Bumper Applique is free of any remaining premask adhesive after installation. Clean the Bumper Applique with soap and water if necessary.	No premask adhesive remaining on Bumper Applique.
	If an installation error occurs, i.e. scratched / marred film, dirt / debris under film, crooked installation, etc., installer should remove, discard and replace the Bumper Applique.	Bumper Applique is installed correctly.

Care & Cleaning

Wash car with soapy water as needed. (Do not use other chemical based cleaners.)